

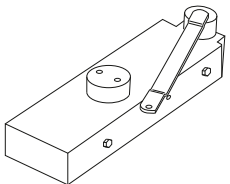

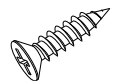

# RiEx

	A	1x		J	8x
	B	1x		K	12x
	C	2x		L	2x
	D	1x		M	3x
	E	1x		N	2x
	F	2x		O	2x
	G	2x		P	2x
	H	2x		Q	2x
	I	2x		R	
	S				

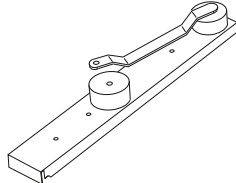
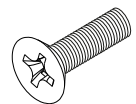
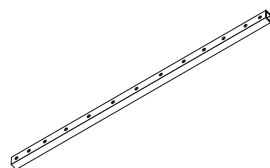
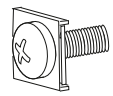
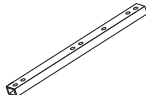
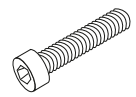
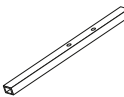
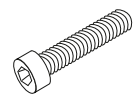
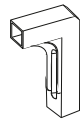
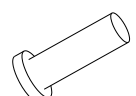

2

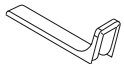
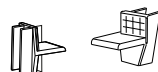
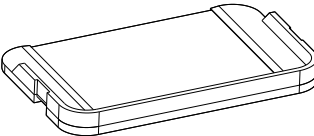
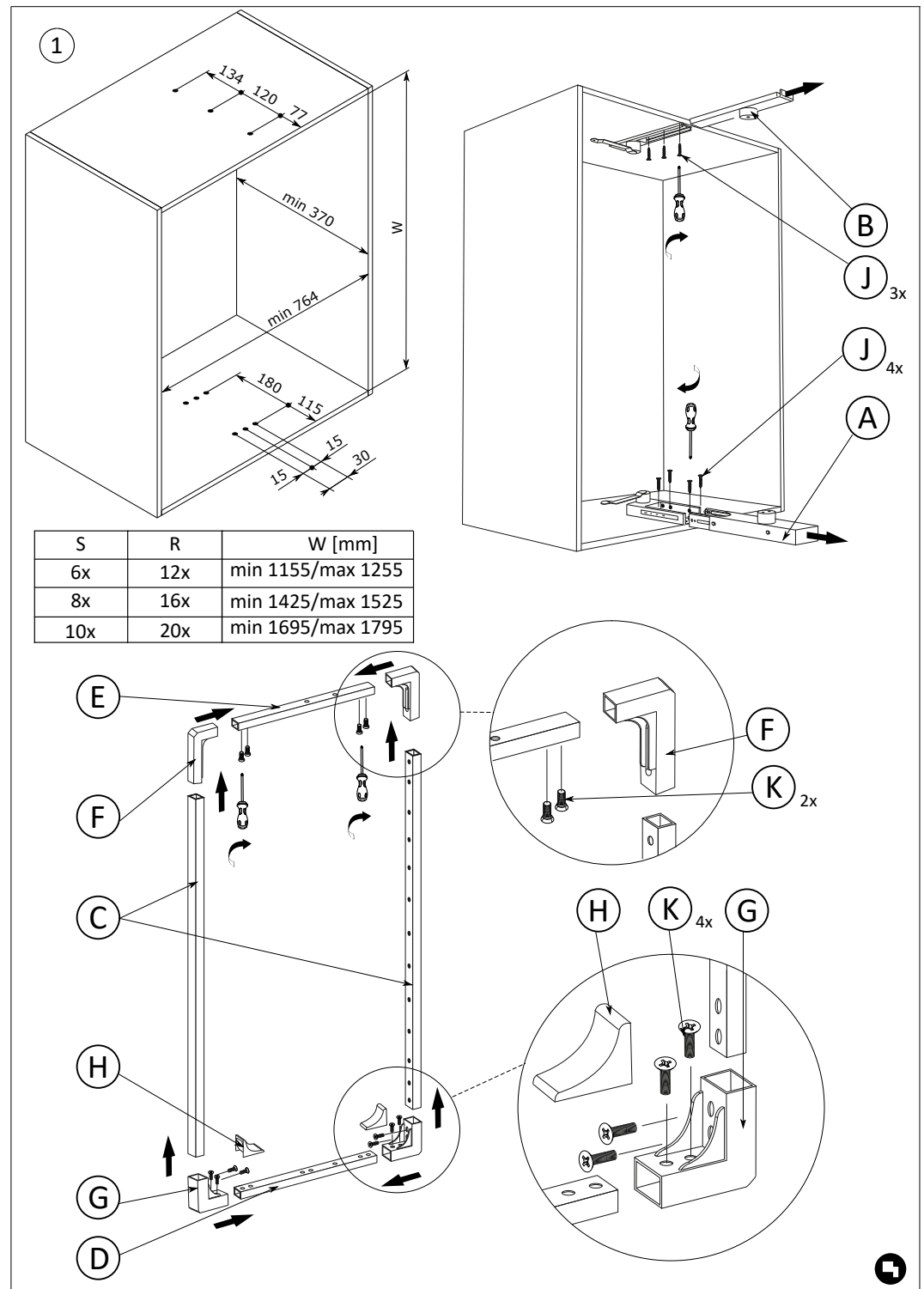
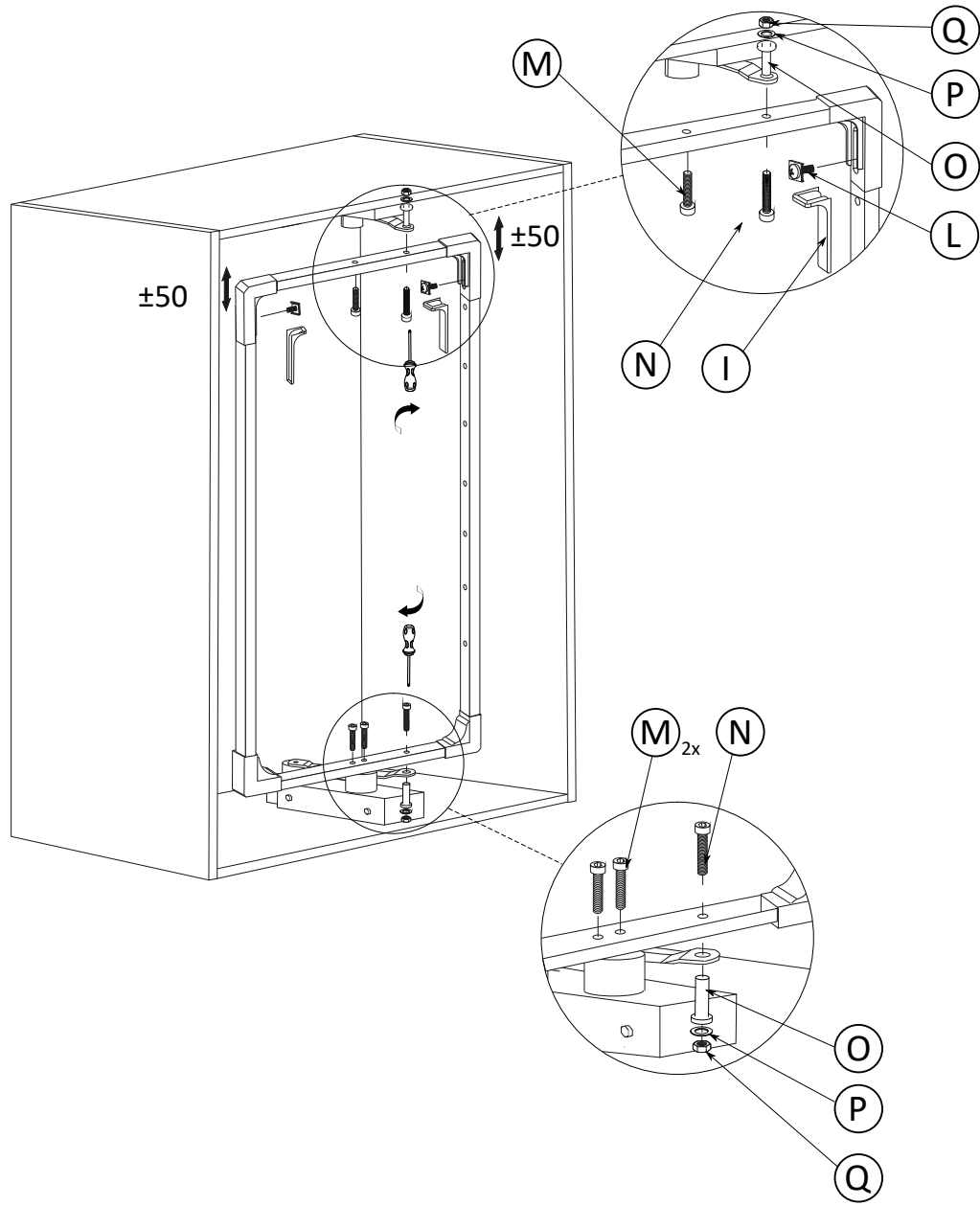

3

