

STYLEA

5925UJI065L51-10 DOM23

EAN 4031582311082

Swivel castor with wheel brake, housing made of Polyamide, with blind hole fitting. Wheel centre made of Polyamide, Tread: TENTEprene (thermoplastic rubber). Plain bearing



BETTER MOBILITY. BETTER LIFE.



Picture may differ from original product

Technical Data

Wheel diameter	65 mm
Wheel width	8 mm
Castor width	43 mm
Centre hole	10 mm
Dome-Ø	23 mm
Offset	25 mm
Swivel Interference	154 mm
Overall height	68 mm
Temperature	- 20 / + 60 °C
Standard	EN_12528
Weight	0.101 kg
Swivel Radius	77 mm
Hardness of tread	Shore A 87
Load capacity	50 kg
Load capacity (static)	100 kg

Structure & Mounting

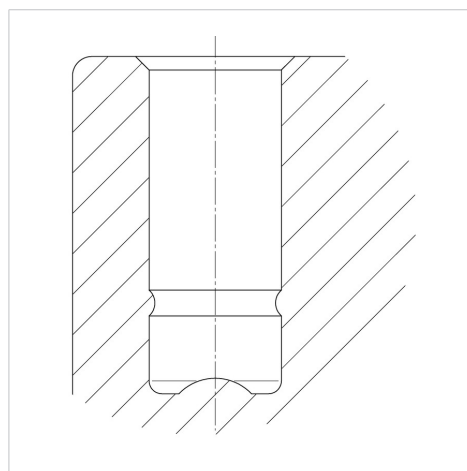

Advantages at a glance

Roll performance	● ● ● ○ ○
Movement noise	● ● ● ○ ○
Attrition	● ● ● ○ ○
Corrosion resistance	● ● ● ● ○